

survitec

PRE-HOSPITAL CARE SYSTEMS

DESIGNED BY COMBAT MEDICS FOR COMBAT MEDICS





PROVEN TO REDUCE PREVENTABLE BATTLEFIELD DEATHS

In the mid-1990s the introduction of Tactical Combat Casualty Care (TCCC) revolutionised the pre-hospital phase of caring for casualties in a combat environment, advocating a new framework designed to significantly increase survivability on the battlefield.

Developed at the highest level under the direction of the US Special Operations Forces (SOF) medical community, TCCC introduced data driven, life-saving procedures and strategies that created a seismic shift in where and how life critical equipment was deployed, and the medical responsibilities, knowledge and training of non-medical soldiers.

Evidence showed the concept of creating a broader medical skillset to counteract preventable battlefield deaths was highly effective. The US Military TCCC system has since been adopted by most allied countries and is considered the gold standard treatment protocol to mitigate losses from battlefield operations.

Survitec embodies the very DNA of this standard, with a qualified, scalable, and rapidly deployable capability. Survitec Pre-Hospital Care System (PCS) is a complete end to end solution, and the only offering available today that combines user defined module designs, tactical medical training, expert support, and a servicing and restock competency anywhere on the globe. Survitec is staffed and managed by an all-veteran SOF Medic team. Our offering has been informed by years of real world combat deployment and previous experience delivering full spectrum pre-hospital systems at national program level. This heightens our understanding of what works best in the field, along with the ability to implement this framework into any host nation or NATO force.



Ensures rapid deployment of life critical care by equipping all military personnel with the training and tools to effectively reduce preventable battlefield deaths and aid in the recovery of battlefield casualties

HIGH QUALITY
COMPONENTS/
MODULES



TACTICAL AND
EMERGENCY PRE-
HOSPITAL TRAINING



END TO END
EXPERT
SUPPORT



GLOBAL SERVICING
AND RESTOCK
NETWORK



ABILITY TO INSERT LIFE SAVING CAPABILITY AT
SOLDIER AND PROGRAMME LEVEL

SCALABLE EQUIPMENT CAPABILITY

From basic care, through to specialist casualty sustainment solutions

Compact and soldier mounted, worn by operative with basic medical training

Comprehensive, shoulder mounted system, worn by expert combat medic



CONFIGURABLE FOR ANY MISSION SCOPE

Access capabilities, mobility, and critical care components for any size or deployment phase

CONVENTIONAL SUPPORT ENVIRONMENTS

AUSTERE AND FAR FORWARD ENVIRONMENTS

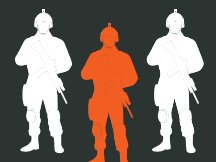

FIELD HOSPITAL

BATTALION

MASS CASUALTY

SECTION

TEAM

STANDARDISED LEVEL OF CARE



PCS MODULES

Subject matter experts at a component level

Working in partnership with over 44 leading medical companies we supply only the very best equipment, with each component carefully packed into a suite of modules optimised for the 3 phases of care -



Each module has been designed by our specialist team of SOF medics and rescue professionals to maximise user interface, speed of care and mobility of equipment. Our pre-hospital care system delivers modular capabilities for several different trauma scenarios including extraction, field mobility, tactical field care, tactical evacuation care, sustainment care, mass casualty care, far forward environments, CBRN environments and naval operations. This grants the combat medic a full life saving capability from patient access in field to hand off at hospital level.

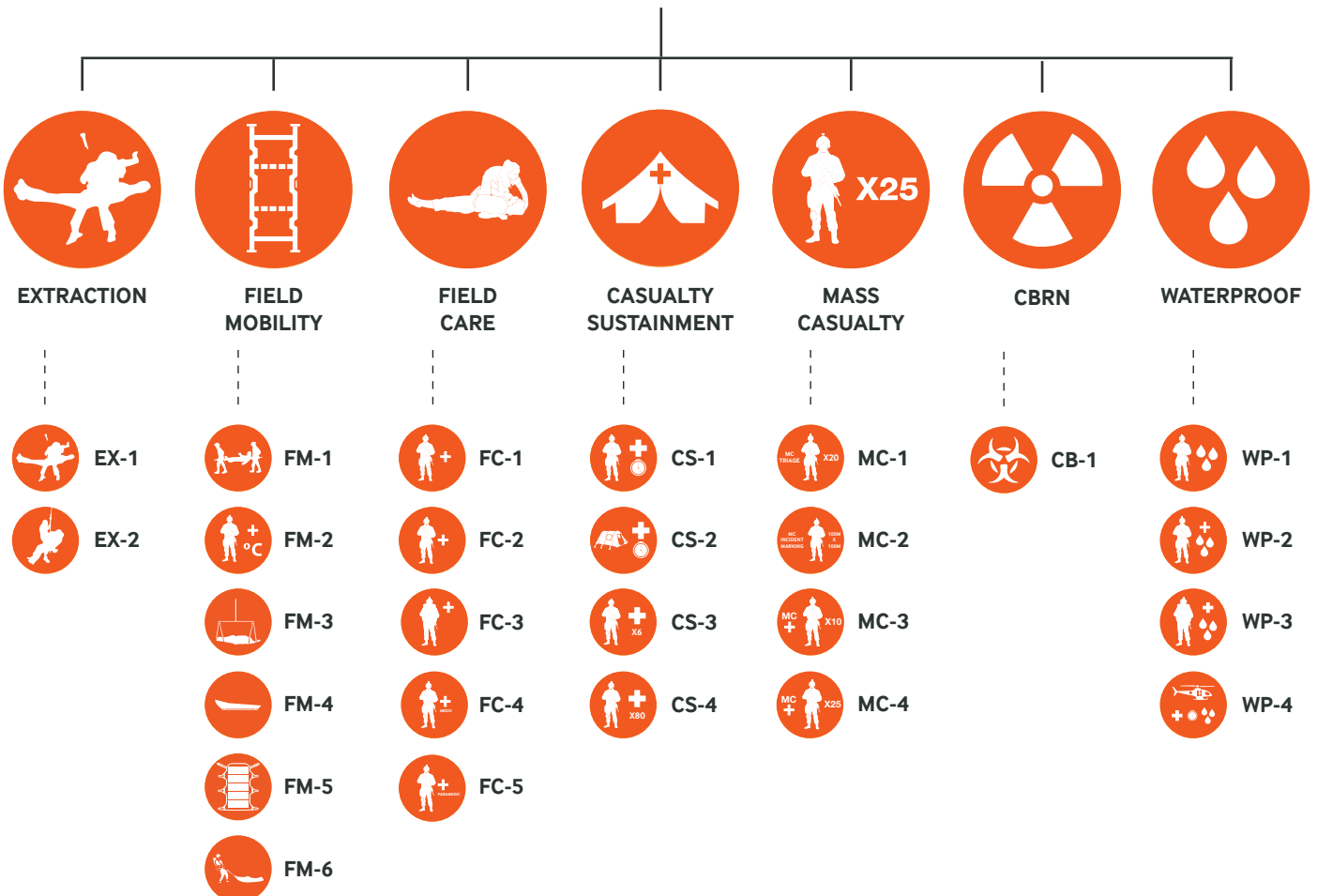



EXTRACTION



EX-1
Rescue Stretcher
Module



EX-2
Rope Rescue
Module

Extraction and rescue are critical components of survival. Specifically, extraction is the most time-consuming and technically challenging part of any rescue operation. Teams are increasingly encountering compromised vehicles and structural collapses. The Extraction Kit

ensures decentralised personnel have the organic capability and equipment necessary to self-recover casualties and configure standard and non-standard vehicle platforms for Quick Reaction Force (QRF) rescue contingencies.

Extraction 1 (EX-1) Rescue Stretcher Module

The EX-1 is man packable and can be transported via an innovative ergonomically designed backpack. It has the capability to extricate casualties with serious spinal injuries from all terrain, including water obstacles, during day or night operations, and can transition a patient to a rigid litter for ground/air evacuation.

DIMENSIONS		
Length (cm)	Width (cm)	Depth (cm)
88	41	40

Colours: Multicam, Coyote.
Nation specific available

Man packable
backpack system

Transportable
by 1 operator

Weight: 19kg
(fully packed)



1 x PJ Skedco® Litter

1 x Neck Brace

2 x Sam® Splints

1 x Tag-Line System

1 x Load-Carriage Pack System

1 x Hypothermia Kit

1 x SKEDCO®
Inflatable Flotation System

1 x Oregon Spine Splint System

Extraction 2 (EX-2) Rope Rescue Module

The EX-2 module offers the capability to safely access and recover casualties from high angle terrains and urban obstacles using rope and rigging equipment. This includes immediate water rescue and ground safety line operations for vertical hoist extractions of casualties up to 2500 lb. breaking strength.

DIMENSIONS		
Length (cm)	Width (cm)	Depth (cm)
53	43	45

Colours: Multicam, Coyote.
Nation specific available

Man packable
backpack system

Transportable
by 1 operator

Weight: 21kg
(fully packed)

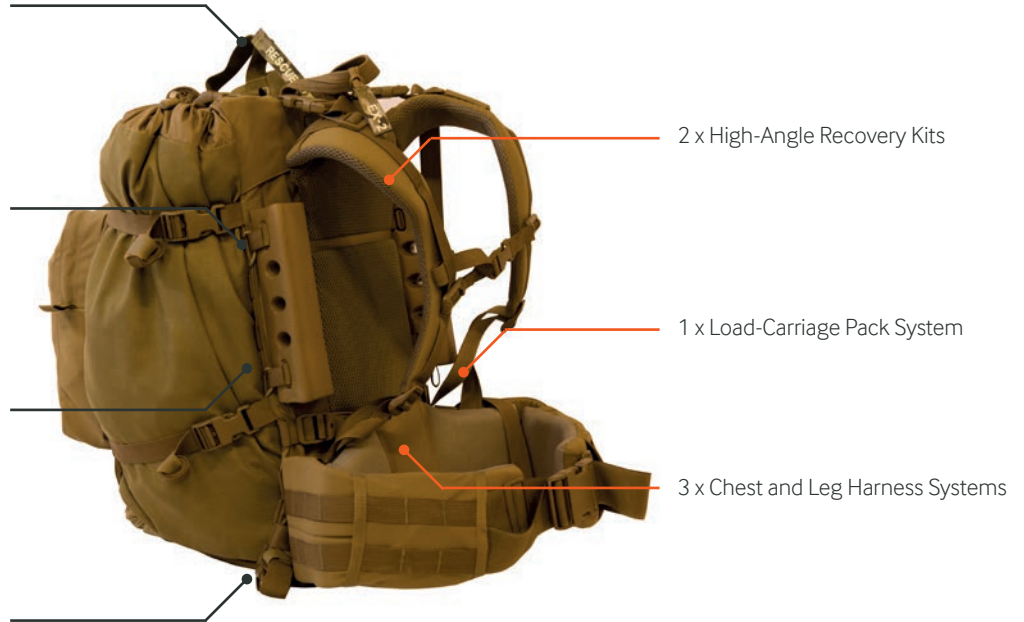

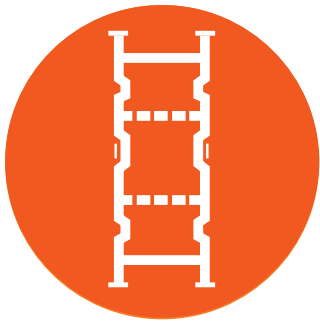

FIELD MOBILITY



Field Mobility 1 (FM-1)
Rigid Stretcher
Module



Field Mobility 2 (FM-2)
Hypothermia System
Module



Field Mobility 3 (FM-3)
Stetcher Hoist
Module



Field Mobility 4 (FM-4)
Pulk
Module



Field Mobility 5 (FM-5)
Fabric Stretcher
Module



Field Mobility 6 (FM-6)
Drag Stetcher
Module

Field Mobility provides the advanced medic items to support tactical field care. This immediate response solution is a specialised mounted system, which can be custom packed to maximise the ability to perform in a grab-and-go situation. The kit enables the transport of patients over rough

terrain for extended distances with the option of a multitude of quad-folding rigid litters, and the addition of thermal property care items.

Field Mobility 1 (FM-1) Rigid Stretcher Module

The FM-1 module has the capability to secure and safely transport a casualty on a rigid litter through all phases of pre-hospital care to a Level III medical facility. It can carry any one of several quad-folding litters with all of the additional medical supplies required to meet mission objectives.

DIMENSIONS		
Length (cm)	Width (cm)	Depth (cm)
55	33	38

Colours: Multicam, Coyote.
Nation specific available

Man packable
backpack system

Transportable
by 1 operator

Weight: 10.6kg
(fully packed)



1 x Life Bed System

1 x Quad-Folding Litter with
Restraint System

4 x Hands Free Litter Carry Straps

Field Mobility 2 (FM-2) Hypothermia System Module

The FM-2 module is designed for hypothermia prevention. This module combines three best in class products that have the ability to rewarm casualties with decreased body temperature. This is done using a full-body wrap with hood, reflective warming blanket, fluid absorption, and insulation from the ground using Life Bed technology.

DIMENSIONS		
Length (cm)	Width (cm)	Depth (cm)
30	25	8



Field Mobility 3 (FM-3) Stetcher Hoist Module

The FM-3 Module allows users to hoist vertically or horizontally with or without a stretcher. The module is designed to integrate with current stretchers, allowing them to be used in vertical or horizontal hoisting and high angle rescue operations.

DIMENSIONS	
Length (cm)	Diameter (cm)
54	23



Field Mobility 4 (FM-4) Pulk Module

The FM-4 Module has been designed for the quick and efficient movement of an injured casualty on a snow covered terrain. The module comprises of a single casualty sled that can be pulled by either members of the patrol or with a snow mobile draw bar that can be attached to a snowmobile for a speedier evacuation.

DIMENSIONS		
Length (cm)	Width (cm)	Depth (cm)
227	59	60

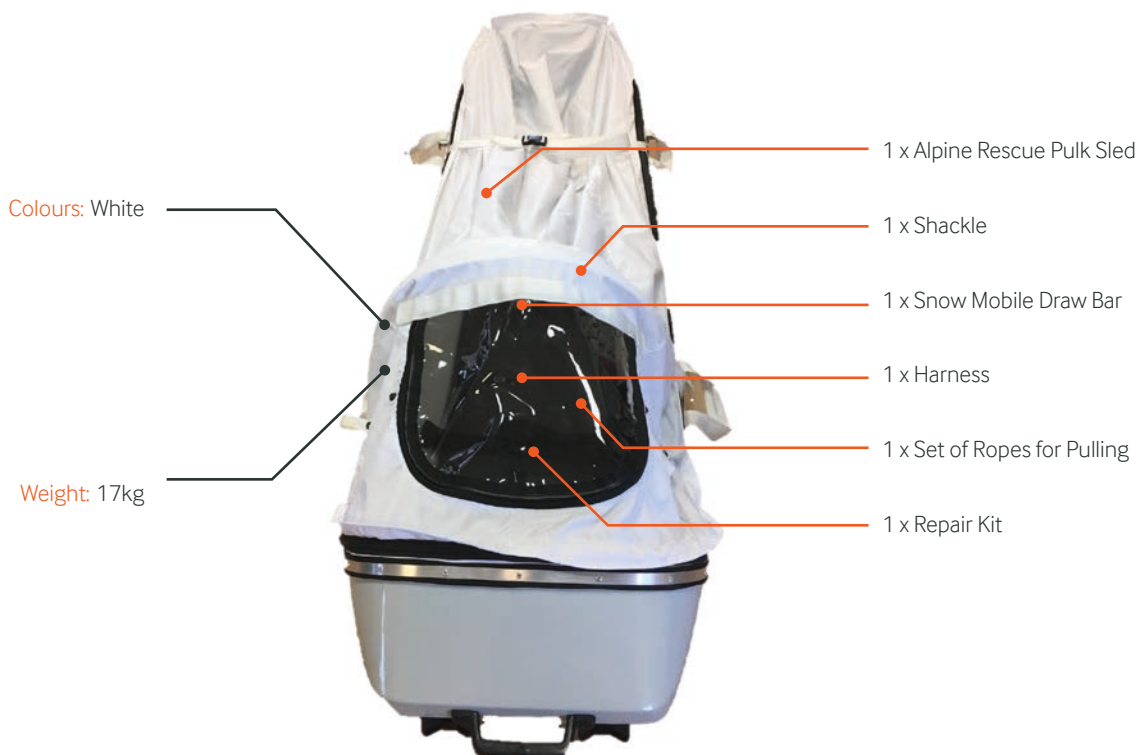

Field Mobility 5 (FM-5) Fabric Stretcher Module

The FM-5 module is a lightweight rescue stretcher suitable for the safe extraction and evacuation of a casualty. This module enables a medic to package and move a single patient from the point of injury to tactical field care.

DIMENSIONS	
Length (cm)	Dia (cm)
28	13.4



Field Mobility 6 (FM-6) Drag Stretcher Module

The FM-6 module Drag Stretcher Module comprises of Life Bed Critical Care and a single modular lightweight rescue stretcher packed in a Waterproof Bag. This module allows safe extraction and evacuation of a casualty with extended drag and life bed critical care capability for one casualty.

DIMENSIONS	
Length (cm)	Dia (cm)
65	27





FIELD CARE



Field Care 1 (FC-1)
Individual First Aid Kit
Module (IFAK)



Field Care 2 (FC-2)
Advanced First
Responder Kit Module



Field Care 3 (FC-3)
Medic Pack Module



Field Care 4 (FC-4)
Combat Medic Pack
Module



Field Care 5 (FC5)
Combat Paramedic
Pack Module

Field Care enables the combat medic to perform critical first aid to combatants on the battlefield and potentially under fire. The Field Care kit provides a completely portable capability to perform immediate self-

aid and buddy aid at the point of injury. The number and complexity of components along with its packing system can be scaled depending on the level of care required.

Field Care 1 (FC-1) Individual First Aid Kit (IFAK) Module

The FC-1 module is the all-in-one solution for individual first aid kits (IFAK). The IFAK retains all necessary supplies for immediate self-treatment in a low-profile package that can either be attached via MOLLE or worn on a duty belt. IFAK content packages are available in two variations: law enforcement and military.

DIMENSIONS		
Length (cm)	Width (cm)	Depth (cm)
30	20	8

Colours: Multicam, Coyote.
Nation specific available

Man packable waist belt system

Transportable by 1 operator

2 x Soft tourniquets

Weight: 0.66kg
(fully packed)



1 x Compressed Gauze

2 pairs x Nitrile gloves

1 x Control wrap 4"

1 x 4" modular bandage

1 x Smart Card/Sharpie

Field Care 2 (FC-2) Advanced First Responder Kit Module

The FC-2 module enables the Advanced First Responder (AFR) or higher to treat patients with both trauma and exposure injuries. FC-2 is able to provide emergency medical treatment at the point of injury and perform effective tactical field care. FC-2 contains a large number of medical components used to treat several common trauma conditions including hypothermia and massive haemorrhage.

DIMENSIONS		
Length (cm)	Width (cm)	Depth (cm)
36	30	30

Colours: Multicam, Coyote.
Nation specific available

Man packable
waist belt system

Transportable
by 1 operator

Weight: 19kg
(fully packed)



1 x Minor wounds kit

1 x Acute Soft Tissue
Muscular Injury Kit

1 x Extremity Fracture Kit

1 x Eye Injury kit

1 x Abdominal Injury Kit

Field Care 3 (FC-3) Medic Pack Module

The Field Care Module (FC-3) module is a state of the art medic bag designed for the warfighter medic. It utilises a removeable organiser panel and pouch system which maximises configuration options while minimising encumbrances.

DIMENSIONS		
Length (cm)	Width (cm)	Depth (cm)
53	37	30

Colours: Multicam, Coyote.
Nation specific available

Man packable
backpack system

Transportable
by 1 operator

Weight: 18kg
(fully packed)



1 x Massive hemorrhage kit

1 x Respiratory kit

1 x Basic burn injury kit

4 x Iv kit

1 x Head injury kit

1 x Extremity fracture kit

1 x Hypothermia kit

Field Care 4 (FC-4) Combat Medic Pack Module

The FC-4 module enables a combat medic to provide emergency treatment at the point of injury and perform effective tactical field care. The module includes items to aid treatments such as in chest injuries, wound packing, massive hemorrhage control, acute muscle and bone injuries, abdominal wounds and airways.

DIMENSIONS		
Length (cm)	Width (cm)	Depth (cm)
54	38	33



Field Care 5 Combat Paramedic Pack (FC-5)

The FC-5 module includes a variety of items to aid treatment of respiratory injuries, IV Kit, Fast kit with syringes, amputation, burns, airway, and includes several pockets to store items such as gauze, drugs, bandages, and tourniquets.

DIMENSIONS		
Length (cm)	Width (cm)	Depth (cm)
62	37	33

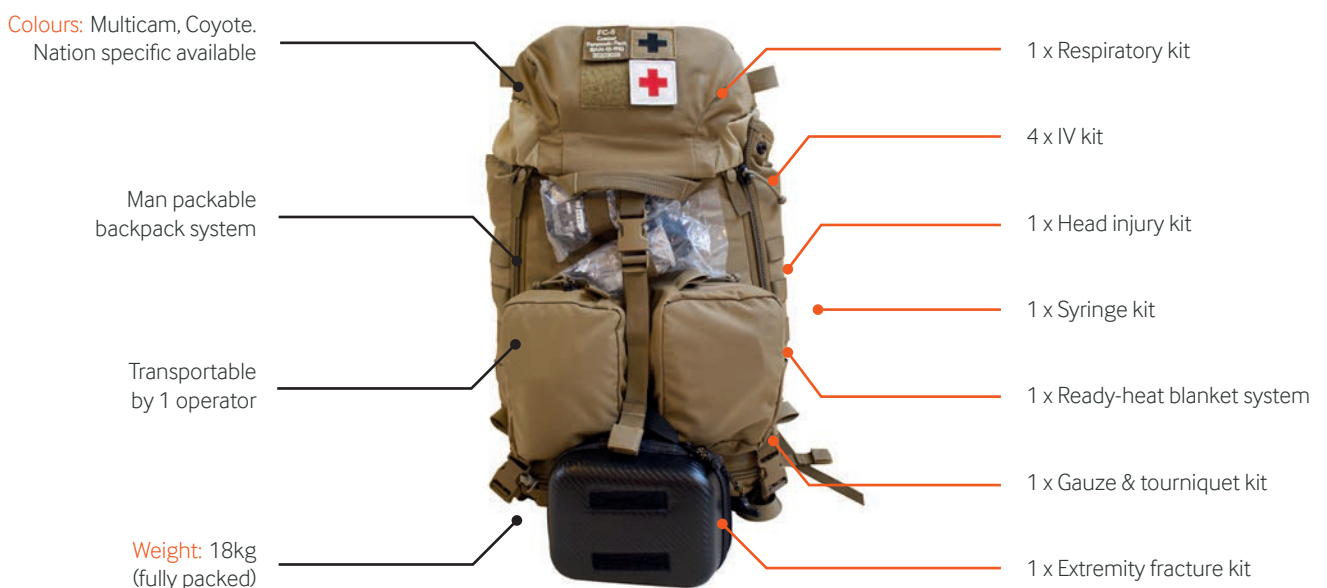



CASUALTY SUSTAINMENT



1 Casualty Sustainment 1 (CS-1)
Prolonged Field Care Pack Module



1 Casualty Sustainment 2 (CS-2)
Casualty Resuscitation Station
Module



1 Casualty Sustainment 3 (CS-3)
Nursing Treatment Station
Module



1 Casualty Sustainment 4 (CS-4)
Doctor's Treatment Station
Module

The Casualty Sustainment Kit includes modular bags and cases that contain the required medical materials necessary to sustain multiple patients for 72 hours and can also provide the additional medical supplies needed in mass casualty situations. Both the CS-1 and CS-2

Sustainment medical packs and panels may be deployed in a hanging configuration while retaining their care and supply items in removable pouches.

Casualty Sustainment 1 (CS-1) Prolonged Field Care Pack Module

The CS-1 module enables patient prolonged field care for 72 hours. As mission timelines continue to increase and access to higher levels of care decrease, the CS-1 module enables care providers to operate self-sufficiently. It includes several critical items used to resolve common injuries such as respiratory, airway and circulation issues.

DIMENSIONS		
Length (cm)	Width (cm)	Depth (cm)
70	53	44

Colours: Multicam, Coyote.
Nation specific available

Man packable
pouch system

Transportable
by 1 operator

Weight: 15.9kg
(fully packed)



Casualty Sustainment 2 (CS-2) Casualty Resuscitation Station Module

The CS-2 module is man-portable and can be transported by multiple operators. The module facilitates the treatment and care of up to 12 patients. It is packaged into a number of user friendly medical chests that contains a comprehensive suite of medical equipment. The module is packaged into a number of user friendly medical chests that contain a comprehensive suite of medical equipment.

DIMENSIONS		
Length (cm)	Width (cm)	Depth (cm)
163	118	150

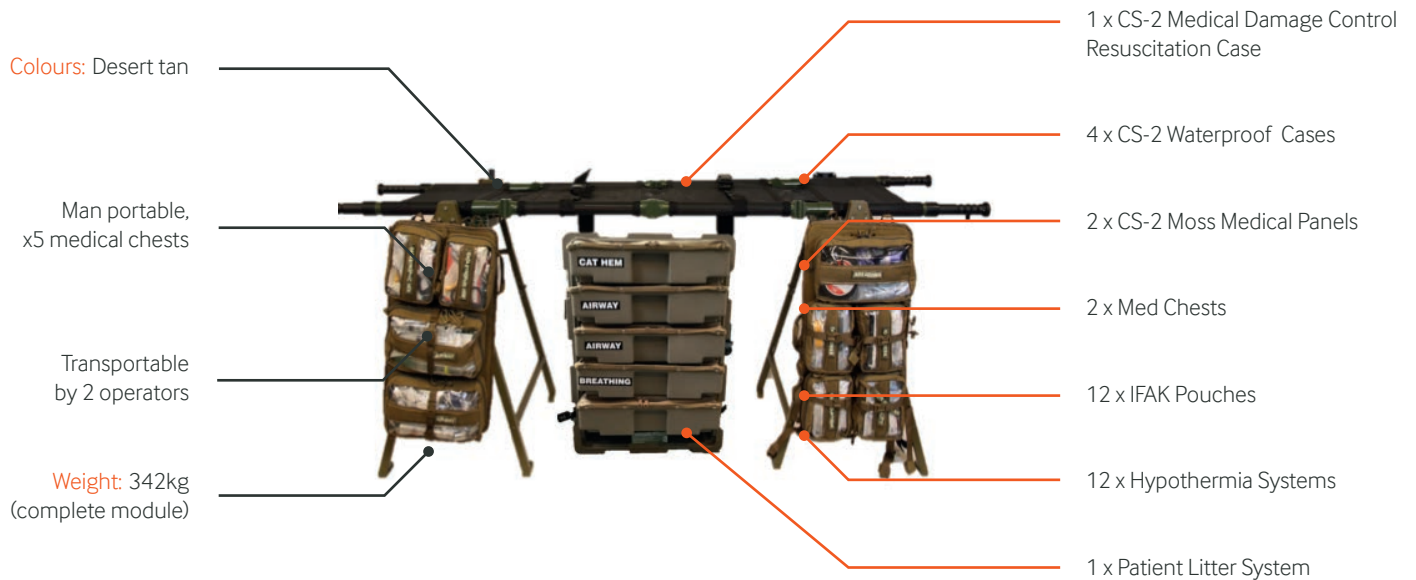

Med Case A1



Med Case A2



Med Case A3



Med Case A4



Med Case B6



Med Case B7



Med Case B8



Med Case B9



Moss Panel x 7



Coolfreeze



ECS Case A5



ECS Case B10

Casualty Sustainment 3 Nursing Treatment Station Module

The CS-3 module is a medical equipment set that enables 2-3 operators to establish a medical installation to care for low-dependency patients awaiting return to unit or evacuation for up to 72 hours. It can be established in any available infrastructure and integrates with CS-2 and CS-4.

DIMENSIONS		
Length (cm)	Width (cm)	Depth (cm)
51	74	45



CONTENTS	
CASE 1	CASE 2
2 x Vomit/Emesis Disposal Bag (pack of 50)	12 x Sterile urine drainage system
200 x Nitrile Gloves	60 x Tena Underpads (various sizes)
12 x Life Bed comfort pac Critical Care	25 x Clinical waste sack
2 x Sharpsafe box	6 x Disposable bed pan
6 x Disinfectant wipes (pack of 200)	30 x Disposable kidney bowl
12 x Ambulance Linen & Pillow Case	6 x Hypothermia kit
3 x Medical journal kit	6 x Acute soft tissue muscular injury kit
1 x BP kit	6 x Physio R Performance tape
1 x Thermometer kit	6 x Instant ice pack
12 x Patient admin kit	36 x Contamination prevention kit
2 x Heavy duty grip seal bags	18 x Hygiene kit
	12 x Fleece blanket (pack of 30)
	18 x Bedbath wipes (pack of 8)
	4 x Heavy duty grip seal bags (various sizes)

WEIGHT: EACH CASE IS 42KG

Casualty Sustainment 4 (CS-4) Doctors Treatment Station Module

The CS-4 module is a doctors treatment station is usually manned by one doctor, one nurse and one medic. The medical equipment set is dimensions to support a unit the size of a batallion. Units can be adjoined for up to 250 people with public health service and can care for approximately 80 outpatients before resupply.

DIMENSIONS			
	Length (cm)	Width (cm)	Depth (cm)
Case 1-3	52	74	45
Case 4	52	74	40

INCLUDES ITEMS FROM CS-2 & CS-3



CONTENTS

CASE 1	CASE 2	CASE 3
8 x Washproof plasters (box of 100)	11 x Procedure Mask with visor	2 x Medical Journal
100 x Reliject Pre-Injection wipes	25 x Disposable Kidney Bowl	1 x Spinal Immobilisation kit
10 x Physio R Ultimate Performance Tape	66 x Exam Gloves (various sizes)	1 x Life bed comfort pac critical care
2 x Wound Care & Bandage Kit	100 x Disposable plastic aprons	2 x Sharpsafe box (4 litre)
14 x Acute Soft Tissue Muscular Injury Kit	2 x Dead casualty kit & handling kit	2 x Compact treatment station
8 x Suture Kit	2 x Tena Underpads (various sizes)	1 x NATO MEDEVAC stretcher
15 x Sterile IV Set	Med Bag with syringes, nitrile gloves, chest drain kit and hypodermic safety needles	

135 x Variety of Sterile Non-Woven Swabs

75 x Sterile IV Catheter (various sizes)

125 x Luer Slip Tip Syringe (various sizes)

130 x Hypodermic Safety Needle (various sizes)

1 x Ampullarium AOS 3 x 1

Med Bag with IV kit and access, Bandage kit, sterile swabs, pre-injection wipes and tourniquet

Field desk with 2 chairs and 2 desk tops x 1



Coolfreeze x 1





CASE 4

DRAWER 1	DRAWER 2	DRAWER 3
1 x Patella Hammer	8 x Physio performance tape	2 x Ethicon Dermabond ProPen
1 x Thermometer kit	10 x Instant Ice Pack	1 x Nail Clippers
25 x Nitrile gloves	5 x Acute soft tissue muscular injury kit	4 x Cornea Scraper
1 x Patient monitor		4 x Curette
50 x Hand & surface wipes		10 x Disposable safety scalpel (various models)
		2 x Suture kit
		1 x Bandage & wound kit

DRAWER FOUR	DRAWER FIVE	BOTTOM OF CASE
1 x Twist Glucometer	2 x Assorted Washproof plasters	1 x Urine analysis test strips
1 x Temperature Data Logger	8 x Normasol Sachet	20 x Urine analysis bottle
1 x Hemoglobin analyser	15 x Blister Plasters	
2 x Microcuvettes	50 x Hand & surface wipes	
1 x Adapter plug UK to European	15 x Sterile wound closer strips	
1 x Streptococcus & Mononucleosis test kit	40 x Vapour permeable adhesive film	
1 x Pre injection wipes (pack of 100)	15 x Tweezers	
	1 x Surgical tape	
	3 x Dressing	



MASS CASUALTY



1 Mass Casualty 1 (MC-1) Casualty Triage Module



1 Mass Casualty 2 (MC-2) Incident Marking Module



1 Mass Casualty 3 (MC-3) Module



1 Mass Casualty 4 (MC-4) Airport Module

The Survitec Mass Casualty Sustainment kit provides the first responder with the capability to render aid in multiple casualty environments. These lightweight, man-packable solutions have been designed as modules to enable efficient treatment for an individual responder or team of

responders. The modules can be dispersed throughout the team to allow simultaneous treatment of multiple casualties in multiple locations.

Mass Casualty 1 (MC-1) Casualty Triage Module

The MC-1 module enables the triage of up to 20 patient casualties during a mass casualty event. The module includes a collection of specific equipment packaged to carry out medical care in a number of different environments including identifying and treating casualties at night.

DIMENSIONS		
Length (cm)	Width (cm)	Depth (cm)
24	19	16

Colours: Multicam, Coyote.
Nation specific available

Man packable pouch system

Transportable by 1 operator

Weight: 1.2kg (fully packed)



1 x SMART Triage Pack

1 x CBRN cards

1 x Red mini cylume

1 x UV mini cylume

1 x Casualty Count Card

1 x Skin Marker

Mass Casualty 2 (MC-2) Incident Marking Module

The MC-2 module facilitates the marking and co-ordination of a mass casualty incident. The module allows responders to quickly set up command and establish the size, scope and the potential chain of events that lead to the incident. This understanding can help enable quicker response and treatment times.

DIMENSIONS		
Length (cm)	Width (cm)	Depth (cm)
55	35	20



Mass Casualty 3 (MC-3) Module

The MC-3 Module manages the treatment of trauma and exposure casualties in a mass casualty situation. The module comprises of 5 Peli cases each containing FC-3 modules, FM-2 modules and MC1.5 Medevac stretchers to utilise patient treatment and transport in a mass casualty situation.

DIMENSIONS		
Length (cm)	Width (cm)	Depth (cm)
120	80	160

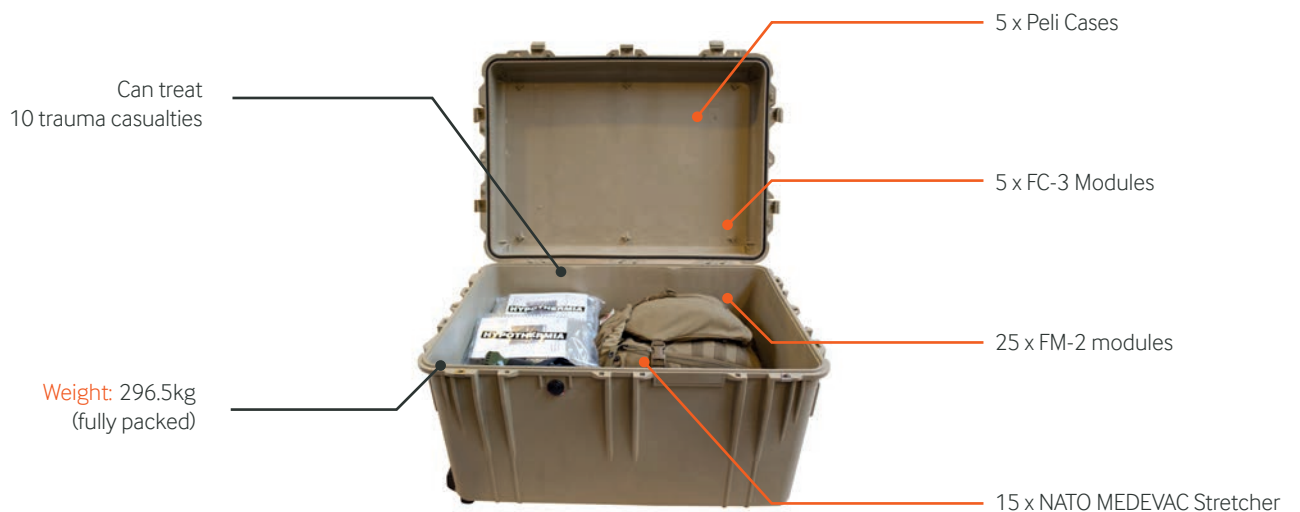

Mass Casualty 4 (MC-4) Airport Module

The MC-4 module is comprised of a compact lightweight composite stretcher system with blankets. The module manages the transport of casualties in a mass casualty situation, including airport disaster readiness.

DIMENSIONS		
Length (cm)	Width (cm)	Depth (cm)
210	47	56

Weight: 60.5kg
(fully packed)

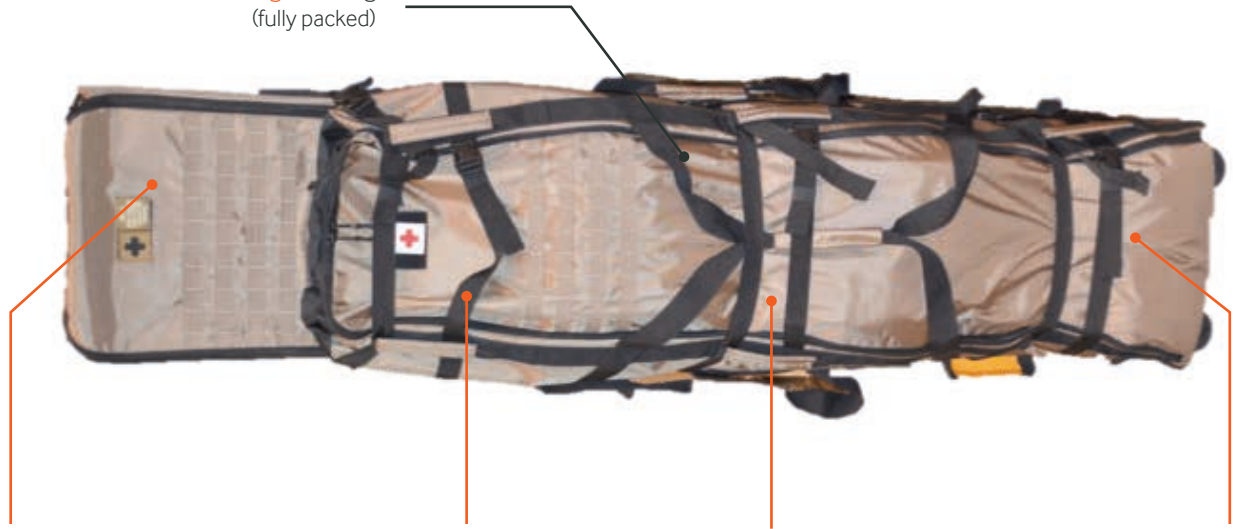

5 x MC-4 Kit

5 x F17 Module Label-MC-4-Glow Thread

5 x F17 Patch-RED CROSS SUBDUED-Coyote

5 x F17 Patch-RED CROSS WHITE-White



1 x Army Blanket Trolley and Straps



10 x Army Blankets



5 x Army Stretchers



1 pair x Super Power Rigger Gloves

Can treat up to 25 casualties



CBRN



1 CBRN 1 Milpod Module

The CBRN kit provides the medic the means to safely extract a CBRN contaminated patient. The specialist stretcher system, which is constructed from CBRN resistant materials has been designed to maximise the ability to execute immediate extraction in an emergency

situation. The stretcher enables the transport of potentially contaminated patients without infecting the first responder team or the aircraft or vehicle used for the extraction.

CBRN 1 (CB-1) Milpod Module

The CB-1 module is a medevac Stretcher system used for extraction and treatment of a casualty that has been injured or contaminated in a CBRN environment. It is designed for rapid deployment in a CBRN environments and is automatically inflated with the push of a button

once released from its stowage bag. The module consists of an inflatable base and frame and a casualty envelope, which the casualty is placed into.

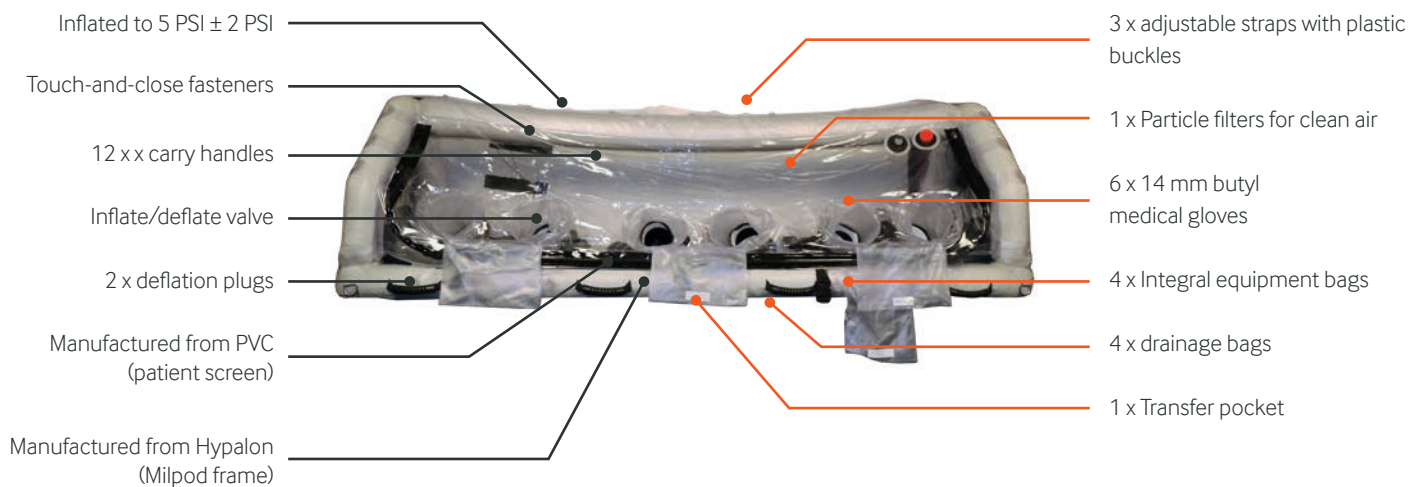



WATERPROOF VARIANTS



1 Waterproof Navy 1 (WP-1) Advanced first Responder Kit Module



1 Waterproof Navy 2 (WP-2) Medic Pack Module



1 Waterproof Navy 3 (WP-3) Combat Medic Pack Module



1 Waterproof Navy 4 (WP-4) Combat Paramedic Module

The waterproof variants kit combines a number of modules from the pre-hospital care set to create a unique fully waterproof solution. Leveraging Survitec's extensive experience in materials technology, the waterproof kit enables complete submersion in water without any damage to its contents.

This kit was designed specifically to meet the requirements of waterborne operations. The suite consists of four medical bags with varying capabilities to enhance survivability in waterborne emergency situations.



FC-2 includes:

- SOF Tactical Tourniquets x 4
- Catastrophic Hemorrhage kit x 1
- Burns & Breathing kit x 1
- Muscle Injuries & wounds kit x 1
- Fractures & Admin kit x 1
- Hypothermia kit x 1

FC-3 AND FC-4 include:

- Massive hemorrhage kit x 1
- Airway kit x 1
- Burns & Breathing kit x 1
- IV Access & Circulation kit x 1
- Syringe kit x 1
- Muscle Injuries & Wounds kit x 1
- Fractures & Admin kit x 1
- Hypothermia kit x 1

FC-5 includes:

- Respiratory kit x 1
- IV Access kit x 1
- Fast Kit with Syringes x 1
- Amputation, Burns and Injuries kit x 1
- Drugs, Hygiene and Admin kit x 1
- Ready Heat Blankets x 1
- Extremity Fracture Kit x 1



TACTICAL AND EMERGENCY PRE-HOSPITAL TRAINING

It is vital that those tasked with carrying out life critical care have a complete understanding of the PCS modules, and are fully trained in the methodologies of administering this care. Survitec PCS training courses cover the entire spectrum of pre-hospital care from component to procedural and environmental syllabus. This includes new equipment training, tactical and remote care and emergency rescue. Our training combines the latest research and guidelines from expert faculties, with

the extensive experience of the Survitec instructors that have delivered tactical medicine in hostile and austere environments. Our focus is to ensure personnel undergoing training are as prepared as possible to deliver high quality, effective treatment to the injured, in any tactical environment.

MODULE FAMILIARISATION

Complete overview of the PCS module structure, components and applications to ensure confident and competent deployment in an emergency situation.



BESPOKE CUSTOMER TRAINING

Bespoke training with our team of medical experts on how our systems and modules integrate together for immediate patient care.



IMMEDIATE EMERGENCY CARE - TACTICAL & REMOTE

Designed to train non-medical personnel to deliver lifesaving medical treatment to the ill and injured in a tactical or remote situation.

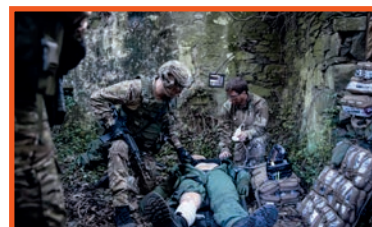

TACTICAL EMERGENCY RESCUE

Provides knowledge and skills to safely and effectively extract those in need of rescue in water, vehicle or high angle accidents.



SURGICAL SKILLS

Provides knowledge, skills and ability to the non-specialist medical professional in surgery. Taught by experienced tactical surgeons.



Even with the very best equipment, the first responder's training and expertise can be the difference of life or death on the battlefield

END TO END EXPERT SUPPORT



GOVERNMENT/MILITARY

Program Development, System Design, Supply Chain Management, Procurement, Fielding, Accreditation, Compliance



SOLDIER

Equipment Procurement and Supply, New Equipment Training (NET), Maintenance, Restock

Saving lives is at the heart of everything we do, and we have a total understanding of this subject. Leveraging our extensive knowledge, global resource and logistical footprint we offer a comprehensive end to end Pre-Hospital solution with security of supply guaranteed. This covers all aspects of the Pre-Hospital Care spectrum including system design for

optimised trauma management, complete supply chain management, country level technical and procurement support, equipment and procedural training, servicing and restock, and expert advice based on previous experience delivering at national program level.

THE WORLD'S LARGEST SERVICE AND RESTOCK NETWORK

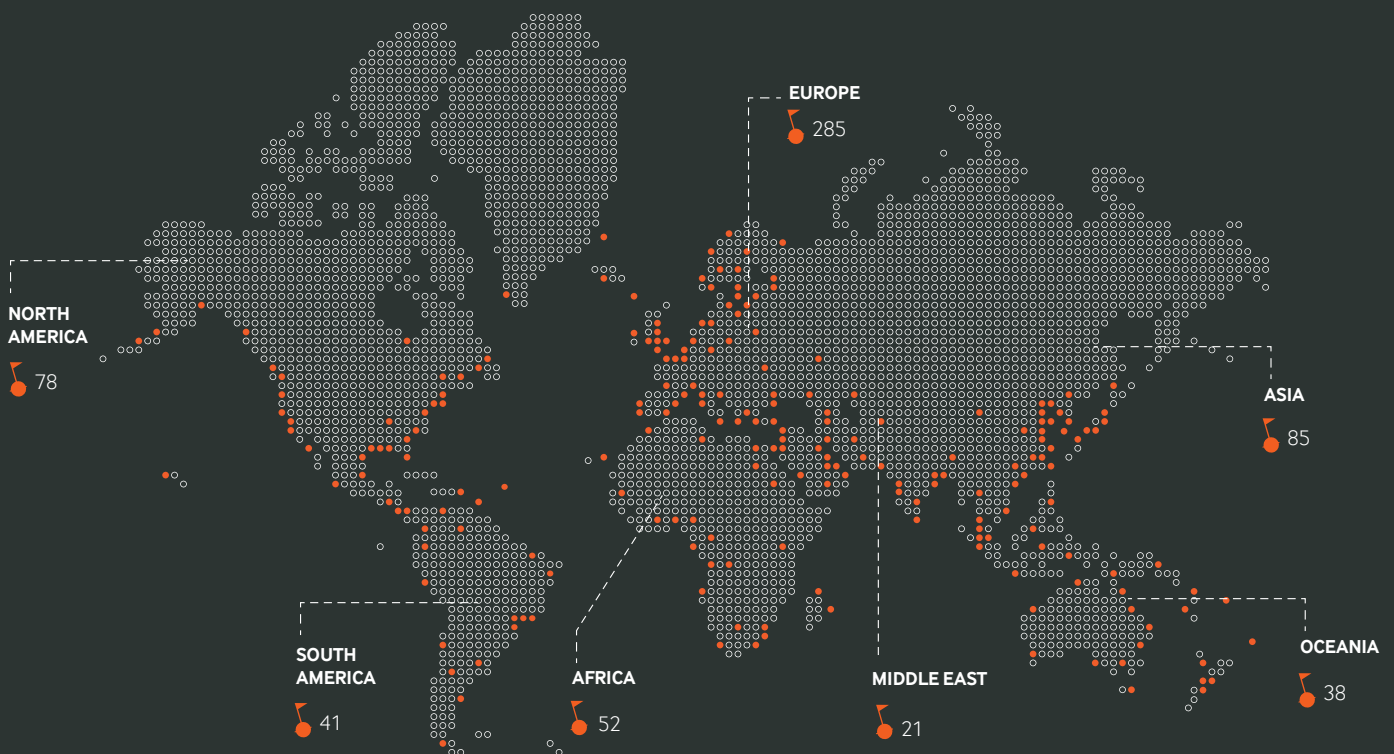



GET IN TOUCH

SURVITEC

1-5 Beaufort Road, Birkenhead, CH41 1HQ, United Kingdom

Email: info@survitecgroup.com

www.survitecgroup.com

Copyright Notice

The copyright, trademarks, domain names and other intellectual property rights in all material and information in this presentation belongs to Survitec Group Limited. All rights are reserved.

Disclaimer

This document provides general information about Survitec Group and its companies, its products and services, and summarises general capabilities and offerings which we deem to be of relevance to our customers. Whilst Survitec has taken appropriate steps to ensure the accuracy of the information contained in this document, Survitec gives no warranty regarding the accuracy or completeness of such information.

This presentation was prepared to provide information and does not constitute a contract. Survitec reserves the right, without prior notice, to change, delete, supplement, or otherwise amend at any time the information, images, and offerings contained in this presentation, or other documents. Survitec shall not be liable for any loss or damage of whatever nature (whether direct, indirect, consequential or other) that may arise as a result of any third party relying on the information contained in this document (but nothing in this disclaimer excludes liability for death or personal injury arising from negligence or any fraudulent misrepresentation).

For further detailed information, prices, terms and conditions, customers should contact Survitec at info@survitecgroup.com